

**EBS**<sup>®</sup>  
Ink-Jet Systeme



- ▶ Operating Manual
- ▶ v. 20111028#4.2
- ▶ EN English

**HANDJET EBS 250**

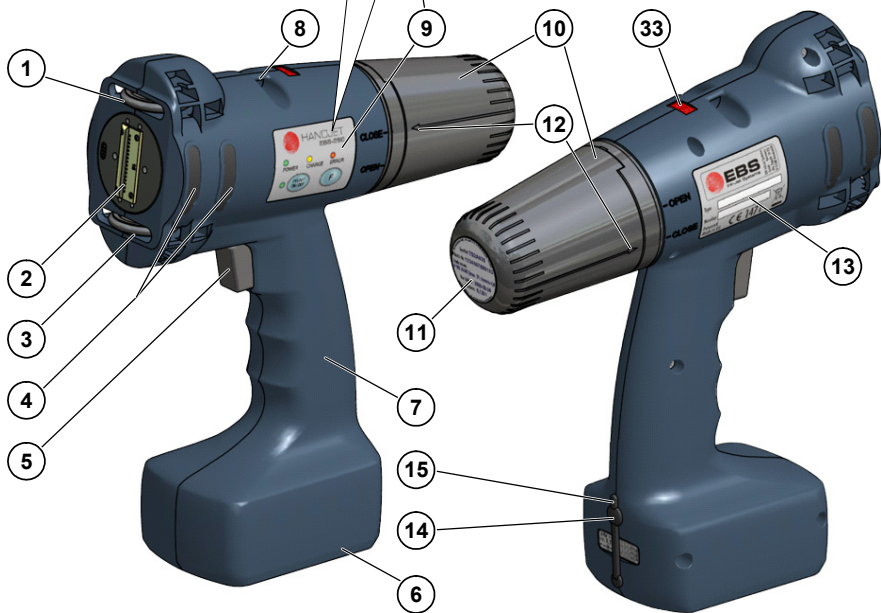
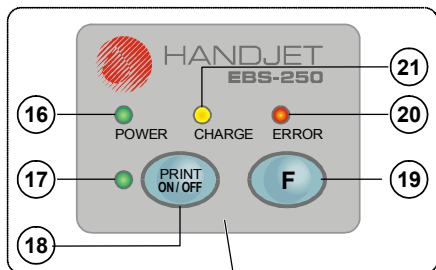
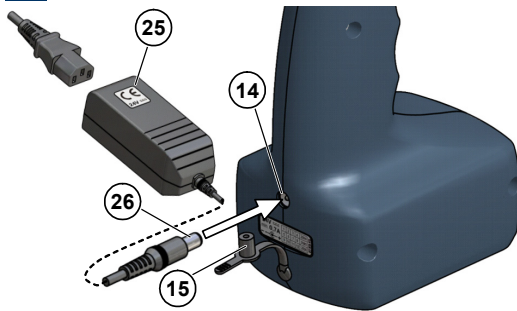

**A****B****C**

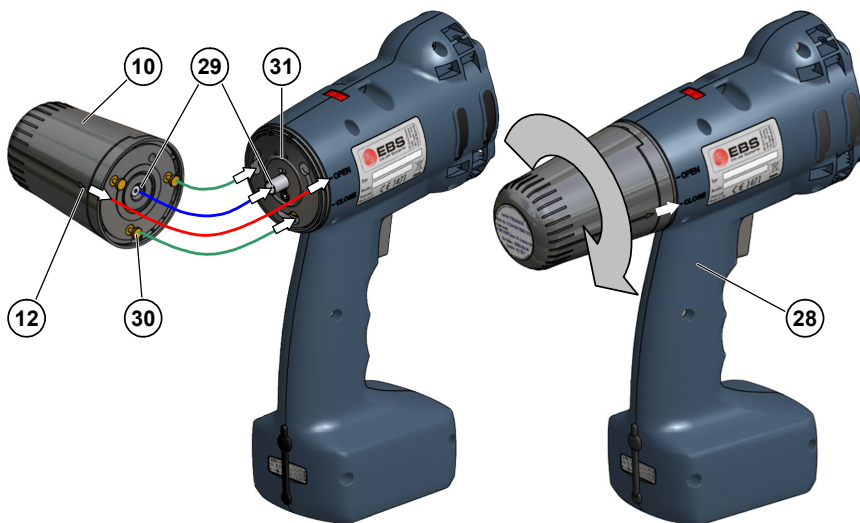
**D****E**

## Components of Portable Printer System

See figures **A B C D E**.

1. Upper guide roll.
2. Nozzle plate - front part of the print head (ink outlet).
3. Lower guide roll, to synchronise printing.
4. Openings with plugs for adjusting electromagnets.
5. Release - a print release button, also used by other functions.
6. Printer base, battery compartment.
7. Printer holder.
8. Hanger.
9. Control panel and keypad.
10. Ink container.
11. Ink container label.
12. Container OPEN-CLOSED indicator.
13. Name plate.
14. Battery charge socket.
15. Charge plug.
16. Power LED indicator.
17. PRINT ON/OFF LED indicator (the **print** state).
18. PRINT ON/OFF button.
19. Function key **F**.
20. Error LED indicator.
21. Charge LED indicator.
22. USB-Bluetooth Module - for wireless (radio) communications.
23. USB plug.
24. Radio transmission LED indicator.
25. Power pack to charge printer batteries.
26. Plug of power pack **25**.
27. Computer.
28. HANDJET® EBS 250 Printer.
29. Non-return valves in the ink container and ink system.
30. Guide bayonets in the ink container.
31. Ink container gasket.

32.  Buzzer - a buzzing signal generator, located inside element **7** of the printer.
33. LED display showing the number of a text file that is ready for printing.

## Signs



Information signs indicating:

- ◆ that the actions described need to be taken with extra or special care,
- ◆ the printer's additional or specific functions or options, which are not described anywhere else,
- ◆ untypical behaviour of the printer and other hints.



**A warning not to perform the operation that might be unsafe or critical for the printer. It requires the user to follow closely the instructions given therein.**

**A**

**B**

**C**

Figure numbering notation

The meaning of LED and other indicators:

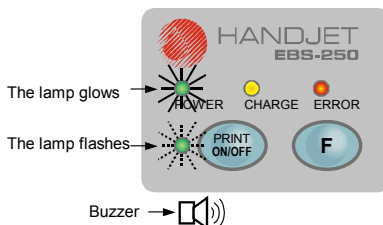

**PRINT ON/OFF button (18)** should be pressed for a short time (<1 sec)



**F button (19)** should be pressed for a short time (<1 sec)







**PRINT ON/OFF button (18)** should be pressed for a longer time (>3 sec)





**F button (19)** should be pressed for a longer time (>3 sec)

Editing markers:

	Font change marker - brown
	Beginning-of-monospaced-text marker (inserts <b>F1</b> ) and end-of-monospaced-text (inserts <b>F2</b> ) - red
	Variable field - incremental counter (inserts <b>Shift+F1</b> ) - blue
	Variable field - decremental counter (inserts <b>Shift+F2</b> ) - green
	Variable field - universal date and time (inserts <b>Shift+F12</b> ) - turquoise

Editing markers:

	Wraparound marker - green
	A marker white in colour means that the cursor is just on the left of the marker (it can be deleted with the <b>BackSpace</b> key).

**F**

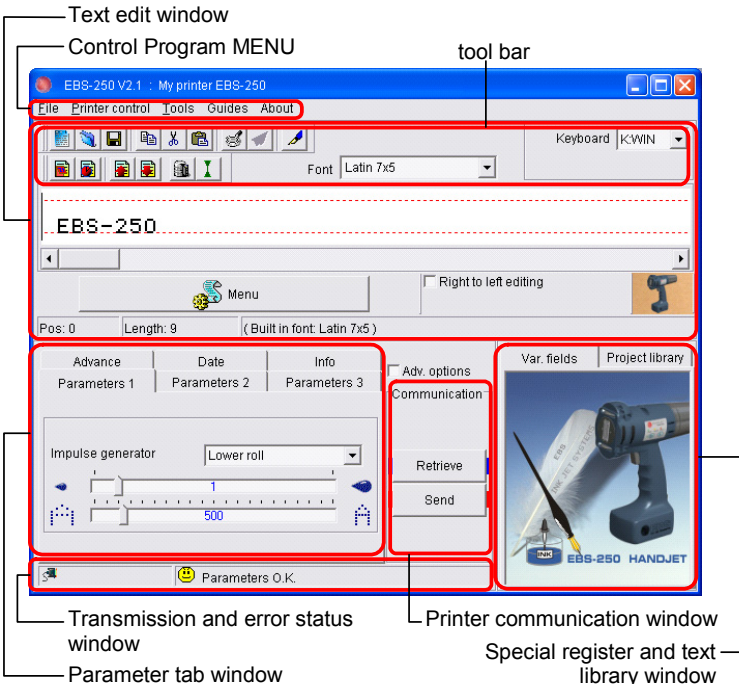

Text edit window

Control Program MENU

tool bar







Transmission and error status window



Parameter tab window

Printer communication window

Special register and text library window

## TABLE OF CONTENTS

	<b>COMPONENTS OF PORTABLE PRINTER SYSTEM.....</b>	<b>4</b>
	<b>SIGNS .....</b>	<b>4</b>
	<b>OPERATIONAL SAFETY .....</b>	<b>7</b>
	GENERAL SAFETY INSTRUCTIONS .....	7
	PROTECTING THE BATTERY PACK.....	8
	WHEN INK OR WASH-UP SPILLS.....	8
	CONTROL OF ELECTROMAGNETIC INTERFERENCE .....	9
	MEDICAL EQUIPMENT.....	9
	<i>Pacemaker</i> .....	9
	<i>Other Medical Equipment</i> .....	9
	OPERATION IN EXPLOSION HAZARD AREAS.....	9
	OPERATION IN AREAS OF BLASTING.....	9
	CONFORMITY MARKING.....	9
	ENVIRONMENTAL PROTECTION .....	10
	<b>APPLICATION .....</b>	<b>10</b>
	<b>INSTALLING AND STARTING UP .....</b>	<b>10</b>
	<b>PREPARING THE PRINTER FOR OPERATION .....</b>	<b>10</b>
	CHARGING THE BATTERY .....	10
	LOW-BATTERY INDICATOR .....	11
	<b>INSTALLING AND REPLACING INK CONTAINER .....</b>	<b>11</b>
	INSTALLING INK CONTAINER IN THE PRINTER.....	11
	HOW TO CHECK WHETHER THERE IS ANY INK IN INK CONTAINER? .....	11
	REPLACING INK CONTAINER .....	12
	<b>SWITCHING THE PRINTER ON AND OFF .....</b>	<b>12</b>
	SWITCHING THE PRINTER ON .....	12
	SWITCHING THE PRINTER OFF .....	13
	<b>INSTALLING AND STARTING THE PRINTER CONTROL PROGRAM.....</b>	<b>13</b>
	INSTALLING CONTROL PROGRAM.....	13
	STARTING THE CONTROL PROGRAM .....	13
	<b>CONNECTING THE PRINTER WITH COMPUTER.....</b>	<b>13</b>
	<b>TEXT FILES AND PRINT PARAMETERS .....</b>	<b>14</b>

<b>HOW TO CREATE A TEXT TO BE PRINTED? .....</b>	<b>14</b>	
REGULAR TEXT.....	14	
<i>Changing Proportional Spacing and Monospacing</i> .....	14	
<i>Using and Changing Built-in Fonts of the Printer</i> .....	15	
<i>Using and Changing Windows® Fonts</i> .....	15	
VARIABLE FIELDS.....	16	
<i>Date and Time</i> .....	16	
<i>Universal Date and Time</i> .....	17	
<i>Object Counters</i> .....	18	
<i>Database Data</i> .....	19	
PRINT PREVIEW .....	21	
<b>HOW TO CREATE AND EDIT A GRAPHICS FILE FOR PRINTING? .....</b>	<b>22</b>	
<b>HOW TO MODIFY PRINT PARAMETERS..</b>	<b>22</b>	
<i>Character Resolution</i> .....	22	
<i>Intensity of Ink Drops</i> .....	22	
<i>Mode of Timing</i> .....	22	
<i>Reflecting a text</i> .....	23	
<i>Rotating a Text</i> .....	23	
<i>Repeating a Text (Repetition)</i> .....	24	
<i>Print Delay</i> .....	24	
<i>Distance between Texts</i> .....	24	
<i>Row Repetition</i> .....	24	
<b>INTELLIGENT CONTROL OF HAND MOVEMENT.....</b>	<b>25</b>	
<b>HOW TO TRANSFER/SAVE TEXT FILES TO/IN THE PRINTER.....</b>	<b>25</b>	
<b>HOW TO CHANGE A TEXT FILE STORED IN THE PRINTER.....</b>	<b>25</b>	
	<b>PRINTING .....</b>	<b>26</b>
<b>PRINTING A TEXT FILE SAVED IN THE PRINTER.....</b>	<b>26</b>	
<b>LINE PRINTING.....</b>	<b>26</b>	
<b>USING A NUMBER OF TEXTS.....</b>	<b>27</b>	
CREATING A TEXT LIBRARY IN THE PRINTER.....	27	
QUICK SAVING/RETRIEVING TEXT FILES TO/FROM TEXT LIBRARY .....	28	
PRINTING TEXT FILES FROM LIBRARY ....	28	
SAVING THE PROJECT LIBRARY ON COMPUTER DISC .....	28	
	<b>MAINTENANCE, STORAGE AND TRANSPORT .....</b>	<b>29</b>
	<b>USER SUPPORT .....</b>	<b>30</b>

<b>PROBLEMS WITH FUNCTIONING AND OPERATION OF THE PRINTER .....</b>	<b>30</b>
<i>Some of the nozzles do not jet ink ...</i>	30
<i>Rinse the nozzles .....</i>	30
<i>The printer does not print .....</i>	30
<i>Boldfaced or Blurred Prints .....</i>	30
<b>QUESTIONS AND PROBLEMS .....</b>	<b>30</b>

<b>ELECTRONIC GUIDES .....</b>	<b>30</b>
 <b>TECHNICAL PARAMETERS..</b>	<b>31</b>
<b>PRINTER ACCESSORIES .....</b>	<b>34</b>

*Dear Users of EBS Ink-Jet Systeme equipment,*

*Please read this manual necessarily in order to get full information about the operation of your device.*

*Disclaimer:*

- *We shall bear no responsibility for damage to the device if it is operated improperly, i.e., inconsistently with this manual.*
- *The application and use of the products are beyond our control and therefore fall exclusively into your scope of responsibility.*
- *As we wish to keep pace with permanently progressing technological development and individual requirements of our clients, we need to reserve the right to change the form, make and technical solutions of our devices. Therefore no data, illustrations or descriptions of this manual shall form any grounds for claims.*
- *We spare no effort to ensure that this manual is reliable, includes all modifications and is free from errors. However, the drawing up and publication process is complex and an error can occur in spite of our endeavours and wishes. We shall bear no responsibility for the consequences of editorial and printing errors in this manual.*

*If your device contains a particular piece of equipment or needs performing an operation that have not been illustrated or described in this manual, or if you have queries on reading this manual, please contact any representative of EBS Ink-Jet Systeme for additional information.*

**EBS Ink-Jet Systeme, the manufacturer, shall not be responsible for damages to the device due to the operation that is inconsistent with the Operating Instructions or due to consequences of drafting or printing errors in these Instructions.**



The printer control program to be installed on your computer is a versatile tool for operating EBS-230 series stationary printers and EBS 250 series manual printers. Therefore some of its components and functions which (i) are used exclusively for EBS-230 series printers or (ii) could be used in EBS-250 series printers but are of little significance for manual printers, will not be described in these Instructions or will be described only briefly.

**These instructions apply to EBS-250C printers with the control program version 2.1.015. In order to check the version of your program view the [About](#) menu.**

## Operational Safety



Before you start your printer for the first time read the hints given below and follow the underlying principles for your own and other persons' safety.

## General Safety Instructions

1. The printer must not be operated in rooms where explosion hazard exists.
2. No prints can be made on objects whose temperature exceeds 100°C at the time of printing.

3. No open fire or spark producing devices or objects are allowed in the area where the device operates.
4. During printing ink drops invisible to people's eye are jetted out of the head at pressure. Do not aim head outlet **2** at any persons, animals or casual objects because they may get splashed with ink unintentionally.
5. The following requirements need to be met when washing, cleaning and maintenance operations are performed or ink containers are replaced:
  - ◆ The operations can only be performed in a workplace that is especially designed for that purpose, when the device is switched off and protective clothing is worn. A fire extinguisher designed to extinguish electrical devices and flammable solvent fires must be placed within easy reach of the device. Air ventilation needs to be ensured at the workplace.

WARNING: The ink is inflammable!

  - ◆ Be careful not to splash the ink. Especially **eyes need protecting**. It is advisable to wear protective glasses.
  - ◆ Protect the ink and the solvent (also waste fluid remaining after the printer has been washed) against fire, high temperature, sparks, electric arc and other electric discharge as they **may cause ignition of these inflammable fluids!**
  - ◆ Do not use plastic vessels to do the washing. Metal vessels are recommended.
6. Protect the printer against dirt, heavy dust and excessive moisture.

7. EBS Ink-Jet Systeme is able to ensure perfect and safe operation of the printer only when original, printer-specific accessories and consumables are used.

### Protecting the Battery Pack

The following principles need to be obeyed to protect the batteries that are built into the printer:

- ◆ Protect the printer against excessive temperature and fire. Do not expose it to strong solar radiation for a longer time.
- ◆ Avoid a sudden change in temperature (cold → hot) that might cause vapour condensation inside the printer and thereby speed up battery discharge and electronic circuit corrosion. Condition the printer for about 1 hour before use after it has been moved from a cool place to a warm one.

### When Ink or Wash-up Spills

- ◆ Should the eyes or skin get irritated with ink or wash-up:



**EYES** rinse the eyes with running water for at least 15 minutes, then see your oculist.  
**SKIN** wash the skin with water and soap.

- ◆ If the clothing has been splashed, take it off as soon as possible.
- ◆ When ink or wash-up spill, wipe out the spilled fluid with a piece of absorbent material, and then remove the material in compliance with fire and health and safety-at-work regulations.



## Control of Electromagnetic Interference

### 1. Properties of high-frequency devices.

Your Ink-Jet printer contains a high-frequency transmitter and receiver. When it is in the ON state, the printer receives and transmits high-frequency (HF) signals. The controller of the Ink-Jet printer system controls energy emitted during printer operation on an on-going basis.

The HANDJET<sup>®</sup> EBS 250 printer complies with all the requirements of the regulations concerning the impact of the HF energy on humans in your country.

### 2. Printer accessories.

If you do not use original EBS parts or printer accessories, including batteries or electronic components, the statutory requirements may not be met and the HF electromagnetic emission limits may be exceeded.

## Medical Equipment

### *Pacemaker*

The pacemaker manufacturers recommend that the distance between a transmitter and the pacemaker be at least 15 cm so that any mutual interference between the two devices is avoided.

### *Other Medical Equipment*

If you use a piece of medical equipment, please ask the equipment manufacturer whether the equipment is sufficiently shielded against electromagnetic radiation. In certain circumstances your doctor may help you gain the information you require.

## Operation in Explosion Hazard Areas

If you work in an explosion hazard area, switch your Ink-Jet printer off, **do not** replace the batteries or **do not**

remove them from the printer and follow all instructions and precautions. Sparking generated by batteries may cause an explosion and/or fire in this hazardous area and result in personal injuries or even death.

The regions where a potential explosion hazard exists are usually marked appropriately. The examples of such regions are: solvent storage areas, fuel storage areas and petrol stations, below-decks onboard ships, storage areas for explosive gases, air mixtures, chemicals and metal or flour powders.

## Operation in Areas of Blasting

In order to avoid interference during blasting (shot firing) the printer should be switched off in blasting areas or in places where the use of radio devices is prohibited.

Follow the operating instructions and information signs.

## Conformity Marking

The HANDJET<sup>®</sup> EBS 250 printer has followed the conformity assessment procedure which resulted in the issue of Declaration of Conformity. This forms the basis for the statement that the HANDJET<sup>®</sup> EBS 250 printer and the manufacturer's accessories, to which this Declaration relates, meet the general requirements and other relevant provisions of the Directive if the printer and the accessories are installed and used in compliance with the manufacturer's instructions:

### **1999/5/EC**

and that they meet the following norms that are harmonised with the above Directives

EN 60950-1:2006,  
EN 61000-6-2:2001,  
EN 61000-6-4:2001,  
EN 50371:2002,

EN 301 489-1 V1.8.1,  
EN 301 489-17 V2.1.1,  
EN 300 328 V1.7.1:2006,  
if the printer and the accessories are installed and used following the manufacturer's instructions.

The HANDJET® EBS 250 printer and USB-Bluetooth modules will bear the following mark:



### Environmental Protection

After the printer and USB-Bluetooth modules have been put out of service, do not take them out together with other domestic waste.



According to Directive No **2002/96/EC** of the European Council on electrical and electronic equipment waste, the HANDJET® EBS 250 printer and USB-Bluetooth modules that have been put out of service must be separated from domestic waste and processed in an environmentally friendly way.

### Application

The HANDJET® EBS 250 printer is designed for marking, labelling, putting prints and simple graphics wherever the use of a manual labelling device is required or preferred.

Prints are put on objects in a non-contact INK-JET way.

### Installing and Starting up

## Preparing the Printer for Operation

### Charging the Battery

A LI-ION top-quality battery has been installed in the printer. It can be re-

charged at any stage of printer operation.

The battery that is new or has not been used for a long time cannot be charged up to its full capacity. Therefore, in order to form the battery follow three charge-and-then-discharge cycles. See figures **A** and **C**.

1. Pull out plug **15** from socket **14** and tilt it.
2. Insert power pack connector **26** to socket **14**, and connect power pack **25** to a wall outlet.
3. Lamp **21** glows when the battery is being charged. Wait until the charging is over and lamp **21** starts flashing.
4. Remove the power pack plug **26** and secure socket **14** with plug **15**. Detach the power pack from the mains and place it into the bag.
5. Do not recharge the battery until it is completely discharged - see **Low-battery Indicator**.

The HANDJET® EBS 250 printer should be stored with its batteries charged. If the printer is to be stored for a longer time (6 months or longer) and its batteries are not recharged, it may work for a shorter time after it has been recharged afterwards or in certain circumstances even stop working. Such a phenomena is caused by the properties of the batteries, which are always subject to the process of self-discharging. In the consequence of self-discharging and long-term storage in the discharge state, the maximum capacity of the batteries may lower or the batteries may get damaged completely.

In order to avoid such a situation, it is necessary to charge batteries of the HANDJET® EBS 250 printer at least **twice a year (however not less frequently than every 6 months)**.

Otherwise, the printer may stop working or the printer operation time after recharging may shorten dramatically.

! The battery is not replaceable as standard.  
When the battery is charged, the printer cannot communicate with the computer but the printer can be used for printing at that time.

## Low-battery Indicator

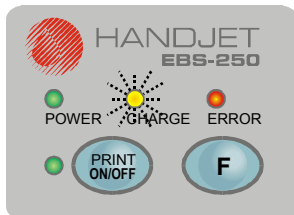

The printer indicates the low-battery condition with a buzzing signal from buzzer **32** and flashing lamp **21**:

- ◆ Short-time, regular flashes mean that the battery is almost discharged, the printer can still be operated,
- ◆ Uniform blinking means that the battery is almost completely discharged. In this condition any further operation may be discontinued because the printer can switch off automatically. Recharge the battery.

## Installing and Replacing Ink Container

See figure **E**.

### Installing Ink Container in the Printer

Every ink container is equipped with a transponder that stores the information on the type of ink and its date of manufacture. The printer has a built-in circuit that scans the data from transponder and thereby it helps check

whether the ink used is of the proper quality.

When the printer is delivered, the ink container is detached. Follow the steps below in order to install the container:

1. Remove the container from packing **10**.
2. Position the container in relation to the back of the printer so that three bayonets **30** of the container aim at guide holes of the container connector. At that moment arrow **12** indicates the **OPEN** position.
3. Insert bayonets **30** into the guide holes and while pressing the container against the printer turn it clockwise, so that arrow **12** is in the **CLOSE** position.

When the printer is switched on for the first time after installation of a container, the container is reviewed for about 10 seconds (lamp **16** flickers while this operation is being performed). Neither can the printer be operated nor can it communicate with a computer over that period. The approval of the container is signalled with lamps **16** and **17** which flicker three times and with audible signal **32**.

If the container is not approved, then after the **PRINT ON/OFF** key **18** has been pressed, lamp **ERROR 20** flickers. Another container needs to be installed in such a case.

### How to Check Whether There is any Ink in Ink Container?

When the printer stops printing make sure that there is no ink in the container. You can assess the ink level in the container in two ways:

1. Weigh the printer on installing a new container - write down the weight. When the container is empty, the weight of the printer is smaller by about 83 grams.

- Detach the full container from the printer, place it with its bayonets **30** up into a vessel whose diameter is slightly greater than the diameter of the container and pour water so that the container starts floating without turning upside down. Mark the water level on the vessel before (line 1) and after (line 2) the full container has been immersed. Then insert the empty container and mark the immersion level (line 3). You can check the ink consumption level at any time by immersing the container in water and comparing the current level with the previous lines (lines 2 and 3). Make sure there is always the same water level in the vessel (line 1).

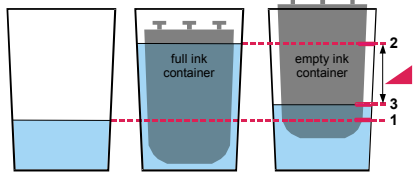

### Replacing Ink Container

If possible, replace the container in dustfree conditions so as to minimise the amount of contaminants getting in to the printer's ink system.



Do not leave the printer with the ink container detached for a longer time than that required to replace the container. While detaching or installing the container be careful not to splash anyone or anything with ink.

- Turn the printer off - see [Switching the Printer Off](#).

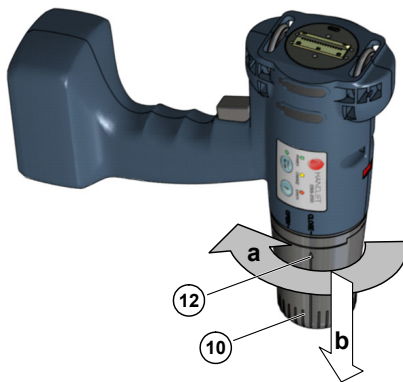

- Put the printer in such a way that the container points downwards, turn empty container **10** to the left (a) so that arrow **12** points to the **OPEN** position. Wait about 3 seconds while holding the container to equalize the pressure.
- Remove the container carefully (b).



See figure [E](#).

- If gasket **31** and contact plates in the guide holes for bayonets are dirty, remove ink leftovers from them with wash-up.
- Install a new container - see [Installing Ink Container in the Printer](#).

### Switching the Printer On and Off



See figure [A](#).

#### Switching the Printer On

Press key **18**, , and while holding it down press release button **5**. When the printer is switched on, lamp **16** glows and a sound signal is heard from buzzer **32** .

Once the printer has been switched on, you can start printing a text that is stored in the printer memory - see [Printing](#).

## Switching the Printer Off

Press key **19**,  , and release button **5** at the same time and keep them down for a few seconds until all lamps stop glowing after buzzing  has been heard.

## Installing and Starting the Printer Control Program

### Installing Control Program

1. Insert the CD supplied along with the printer to the CDROM drive in your computer and wait for the program to start.

 If the programs on the CD do not start running on the computer automatically, start **setup.exe** from the CD's main directory.

2. After the program MENU has been displayed, choose the installation option.
3. Follow the instructions displayed during the installation.
4. After all control program components and USB drivers required have been installed, you can communicate with your printer via a radio link - see [Connecting the Printer with Computer](#).

### Starting the Control Program

1. Click the *EBS printer* icon on the control panel or, if there is no such an icon, start **EBS200.exe** from the folder where the control program has been installed (*C:\Program Files\EBS printers\EBS-250\* as standard).
2. Once started, the control program automatically activates the find-the-printer(s) function and signs the printer on, if the printer is on and the radio communications link operates properly.

## Connecting the Printer with Computer

See figures **B**, **D** and **F**.

The printer communicates with the computer through module **22** via a radio link. The module uses an USB interface.

1. Find a free USB port in your computer.
2. Connect the USB-Bluetooth module **22** to a USB port on your computer via a USB plug **23**.

 If USB drivers of module **22** have been installed during the installation of the control program (see [Installing Control Program](#)), then the module is automatically detected and installed on your computer. Otherwise you are prompted to indicate the location of the drivers on the CD.

3. Place module **22** and the printer so that the widest radio transmission range is ensured.

 Do not cover module **22** with unnecessary shields or objects, especially metal ones.

4. Switch the printer on.
5. Start the control program. The program will find the printer, communicate with it and display a **Printer is found** message.
6. Click the  key (the key is available in the communication window only after the **Adv. options** item has been ticked) to view the printer configuration. Data have been transmitted properly if an **O.K.** message is displayed in the transmission status window.

 If you cannot communicate with the printer, try to configure it in the system once again. From the **Guides** menu start the **Network configuration** creator and follow the creator's prompts.

## Text Files and Print Parameters

### How to Create a Text to be Printed?

#### Regular Text

See figure **G**.  
 Insert texts in the text edit line in the edit window.  
 Use a mouse and the following keyboard keys to edit a text as standard and as you do in other Windows® applications:

 to move the cursor horizontally to the right,

 to move the cursor horizontally to the left,

 to move the cursor horizontally to the right and highlight the text,

 to move the cursor horizontally to the left and highlight the text,

 to delete one character to the right of the cursor,

 to delete one character to the left of the cursor,

 to move the cursor to the beginning of the text,

 to move the cursor to the end of the text.

 You can type in up to 1300 characters in one text.

#### **G** Text edit window

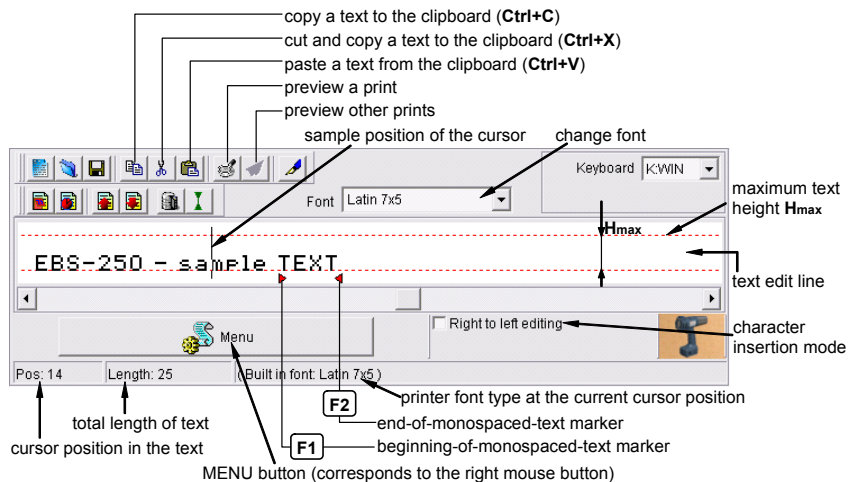

### Changing Proportional Spacing and Monospacing

Proportional fonts are used to insert texts as standard. This means that each letter takes a space proportional to the character width. For example, a letter **W** takes more space than a letter **l**.

When monospaced fonts are used, the character width does not depend on the character. In other words, each character has the same width. The beginning of a monospaced piece of text is usually marked with the **F1** key and the end of a monospaced piece of text is usually marked with the **F2**

key from your computer keyboard. The markers can be deleted as any other characters - with the **Delete** and **BackSpace** keys.

The spacing between proportional (monospaced) characters is set with the **Character spacing (Selective char. spacing)** parameter from the **Parameters 2** tab sheet.

Advance	Date	Info
Parameters 1	Parameters 2	Parameters 3
<input type="checkbox"/> Reflect in vertical		
<input type="checkbox"/> Reflect in horizontal		
Text repetitions	1	
Print delay	0	
Rep. distance	0	
Character spacing	2	
Selective char. spacing	2	

### Using and Changing Built-in Fonts of the Printer

The program uses built-in fonts as standard. In order to change the font type and size at any point of the text, follow the steps below:

1. Position the cursor in the text edit line exactly where another font is to be inserted.
2. Holding the cursor on the text edit line, press the right mouse button (or the MENU button) and select **Font** from the menu displayed. Then select the font type you need from the list displayed, e.g. **Latin 16x10**. You can also do that using the pull-down list called **Font** on the tool bar of the text edit window (see figure **F**). The printer fonts are at the top of the list and marked with the symbol .
3. Move the cursor to another position and insert another font-change marker.

If only one font-change marker  has been inserted, all characters from the marker position to the end of the text are displayed (printed) with the use of the replaced font.

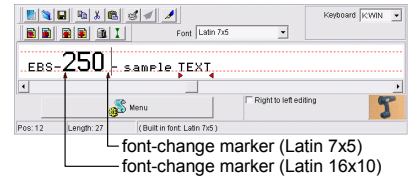
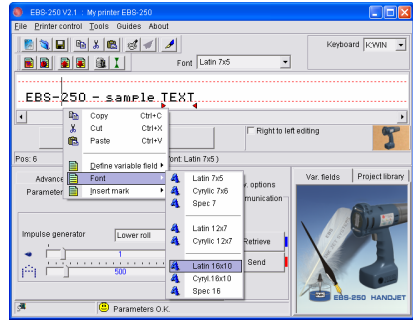

### Using and Changing Windows® Fonts

You can also use Windows® fonts to create texts in your printer.

1. Move to the **Font** list and replace built-in font with one of fonts installed in your Windows®. You can change the font **Size** and the keyboard "language" in Windows®. While increasing the text height do not exceed **Hmax** line because otherwise the excessive top part of the text will be cut off.

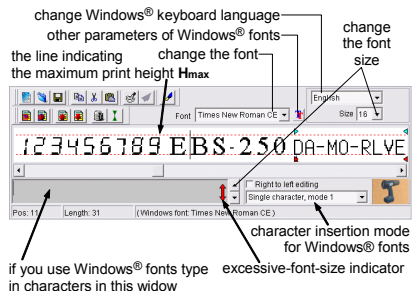

2. Move the cursor to the position where you want to start a text and type in the text. You can change the font at any time.

- There are three character insertion modes you can use:

**Single character, mode 1, Single character, mode 2, Multi character.** Each of them matches Windows® font characters with the capabilities of your printer in a different way according to the font type, language and character insertion mode (the **Right to left editing** parameter).



The number of characters to be input with the use of the Windows fonts is limited – it depends on the font type and size.

### Variable Fields

Variable fields are designated fields of text whose contents are updated automatically after every print. The following events can impact on the contents of variable fields: change in date, change in time, activation of release button **5** and other. Up to 10 variable fields can be used in one text at the same time.



Only the printer built-in fonts can be used to print variable fields; no Windows® fonts can be used.

### Date and Time

In order to synchronize the date and time of your printer with those of your computer move to the **Date** tab and click the **Show PC time** and **Set timer** keys successively.

Parameters 1	Parameters 2	Parameters 3
Advance	Date	Info
Time:	<input type="text" value="12:01:20"/>	
Date:	<input type="text" value="30-09-2011"/>	
Day of week:	<input type="text" value="5"/>	
<input type="button" value="Set timer"/> <input type="button" value="Show PC time"/>		

You can set a different date or time in your printer by setting them in the **Date** tab and transferring to the

printer with the **Set timer** key.

In order to insert the date (time) field that is updated automatically, follow the steps below:

- In the text edit line position the cursor in the place where you want the date (time) to be displayed.
- While holding the cursor on the text edit line press the right mouse button (or the MENU button) and select the command **Define variable field** from the menu displayed. Then select **Insert date (Insert time)** in the list displayed. You can also do that using the () key on the tool bar of text edit window.

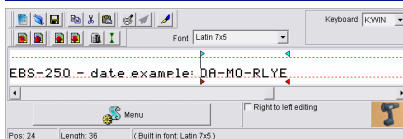
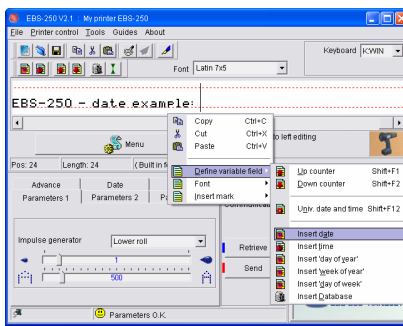

- You can insert a font-change marker on the left or right of the date (time) field.
- You can change separators inside the date (time) field by replacing the existing separators with different characters. You can also remove proportional-text markers.





## Universal Date and Time

Various components of the current date and time can be printed automatically on every object with the use of a **Univ. date & time** variable field. Below, there is a list of characters that can be used to encode the date and time components. The date and time components can be preceded, separated and followed by any characters different from those specified below or by a space.

- D** tens of day in the current date,
- A** units of day in the current date,
- M** tens of month in the current date,
- O** units of month in the current date,
- R** thousands of year in the current date,
- L** hundreds of year in the current date,
- Y** tens of year in the current date,
- E** units of year in the current date,
- B** tens of hour in the current time in the 24-hour system,
- C** units of hour in the current time in the 24-hour system,
- I** tens of minute in the current time,
- J** units of minute in the current time,
- T** tens of second in the current time,
- U** units of second in the current time,
- P** hundreds of day number in the year
- Q** tens of day number in the year
- S** units of day number in the year
- W** tens of week number in the year,
- K** units of week number in the year,
- N** number of day in the week (see below).

The following encoding system is used as standard: 1-Sunday, 2-Monday, 3-Tuesday, ... , 7-Saturday).

The numbering of weekdays can be changed in the following way: on checking the time on your

computer (by clicking the  key) or

on your printer (by clicking the  key) change the number-of-weekday parameter in the **Day of week** box for the date displayed.

For example, Monday, 26<sup>th</sup> September 2011 is encoded as the first day of the week as standard.

But if you set **2** in the **Day of week** box and save the modified parameters (of time, date and day of

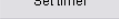
week) to the printer (with the  key), then the following encoding applies: 2-Monday, 3-Tuesday, ... , 1-Sunday. And if you set **5** in the **Day of week** box and save the setting to the printer, then the following encoding applies: 1-Thursaday, 2-Friday, 3-Saturday, 4-Sunday, 5-Monday, 6-Tuesday, 7-Wednesday.

In order to insert a field consisting of various components of the current date and time to be updated automatically, follow the steps below:

1. In the text edit line type in a text containing a subset of the above specified coding characters. The coding characters can be input in any order.
2. Select the characters of the field with the mouse.
3. While holding the cursor on the text edit line press the right mouse button (or the MENU button) and select the command **Define variable field** in the menu displayed. Then select **Univ. date and time** in the list displayed. The same operation can be performed with the menu shortcut Shift+F12.

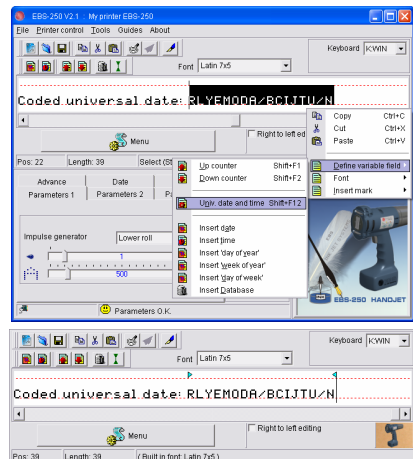

On selecting the print preview option (see [Print Preview](#)) you can see what

the print will look like on 30-09-2011 at 11:08:01 hours or later.

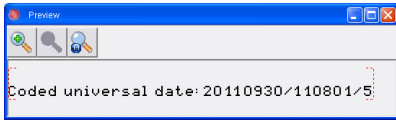

### Object Counters

You can print a consecutive number of print on every object being labelled or at a specified interval on long objects with the use of **incremental or decremental counters**.

In order to insert the field of an incremental (decremental) counter to be updated automatically follow the steps below:

1. In the text edit line position the cursor in the place where you want the counter to be displayed. Insert a font-change or other markers, if required.
2. Type in the setting for the counter: the maximum required number of digits, e.g. zeros, if the counter is to start counting from zero. If counting is to start from a specific number, type in the number and add leading zeros to fill in all counter positions.

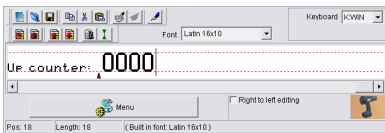

3. Highlight the counter setting with the mouse.

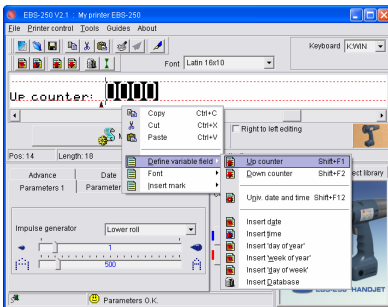

4. While holding the cursor on the text edit line press the right mouse button (or the MENU button) and select the command **Define variable field** in the menu displayed. Then select **Up counter (Down counter)** in the list displayed. The same operation can be performed with the menu shortcut **Shift+F1 (Shift+F2)**.
5. The operation described at points 2, 3 and 4 can be performed by pressing the () key on the tool bar (a 4-digit counter is inserted and you can adjust its length appropriately).

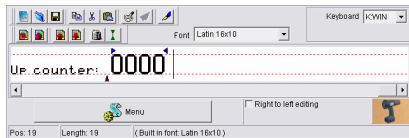

6. You can change other parameters of the counter. Double-click the counter in the variable field list. You can change the increment or select the **Auto save** parameter of the counter.

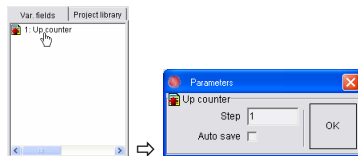

The contents of a volatile counter are lost after the printer has been switched off. With a non-volatile counter the counting can be resumed from its last setting after the printer has been switched on again.



If you place the mouse cursor in the text edit window, above the characters within the counter field, the colour of the non-volatile counter on the variable field list changes from blue to pink (for the volatile counter the colour changes from black to red).

NOTE: An increment (decrement) is added to the counter each time button **5** is pressed and the contents of the incremental (decremental) counter increases (decreases). The only exception is when a text is to be printed repeatedly, that is when the print parameter **Text repetitions>1** or is set to **Continuous**. In such a situation button **5** does not time each of the prints but rather groups of prints. The **Refresh var.fields** parameter from the **Parameters 3** tab decides whether every successive repetitive print modifies the contents of the counters or not. The distance between the beginnings of two consecutive prints produced with repetitive printing is defined with the **Rep. distance** parameter from the **Parameters 2** tab.

**Example:** For the counter defined as above set the **Text repetitions** parameter to **3**.

- a). If the **Refresh var.fields** parameter is set to OFF, the following prints can be produced:

If release button <b>5</b> is pressed for xth time	The following counter contents are printed:		
1	0000	0000	0000
2	0001	0001	0001
3	0002	0002	0002
---	---	---	---
999	0999	0999	0999

- b). If the **Refresh var.fields** parameter is set to ON, the following prints can be produced:

If release button <b>5</b> is pressed for xth time	The following counter contents are printed:		
1	0000	0001	0002
2	0003	0004	0005
3	0006	0007	0008
4	0009	0010	0011
---	---	---	---
333	0996	0997	0998
334	0999	1000	1001

## Database Data

The contents of the database can be printed automatically on every successive object to be labelled owing to the **database** variable field.

 The database handling option is available for the EBS250C printers after an enable code has been typed in. Contact your printer distributor to obtain the code. After the code has been input, the enable setting is saved permanently in printer memory.

The database (also in the form of Excel and text files) can be accessed via an ODBC software interface.

In order to insert a database variable field, follow the steps given below:

1. In the text edit line position the cursor in the place where you want the data to be displayed.
2. While holding the cursor on the text edit line, press the right mouse button (or the MENU button) and select the **Define variable field** command from the menu displayed. Then select **Insert Database** from the list displayed. You can also do that using the  key on the tool bar of the text edit window.

In the window displayed, configure a link to the database:

1. Press the **Connection settings** key and then choose *Microsoft OLE DB Provider for ODBC Drivers* in the *Provider* tab of the *Data Link Properties* window and press the **Next** key.
2. In the *Specify the source data* item of the *Connection* tab choose *Use connection string* and press the **Build...** key.
3. In the *Select Data Source* window press the **New...** key to establish a link.
 

 If a given source is to be used again, it can be chosen from the list and steps 3 to 7 can be omitted.
4. In the *Create New Data Source* window choose a driver for handling Excel files (\*.xls) and press the **Next** key.
5. Type in the name of a new source of data and press the **Next** key.
6. Confirm whether the data source settings are correct by pressing the **Finish** key.
7. In the *ODBC Microsoft Excel Setup* window indicate an \*.xls

file by pressing the **Select Workbook...** key.

8. Then press the **OK** key in successive windows a number of times until you return to the *Connecting database* window.
9. Press the **Connect** key.
10. Select the type of database from the **Type of database** drop-down list box.
11. Fill in the **Table(File) name** box. For Excel files type in the name of a spreadsheet.
12. In the **Search for** box, select the column where all records (lines) are numbered.
13. After the above mentioned options have been set, the first record of the table is read in. Using the **Record number** parameter you can choose the record to start printing with.
14. Press the **OK** button.

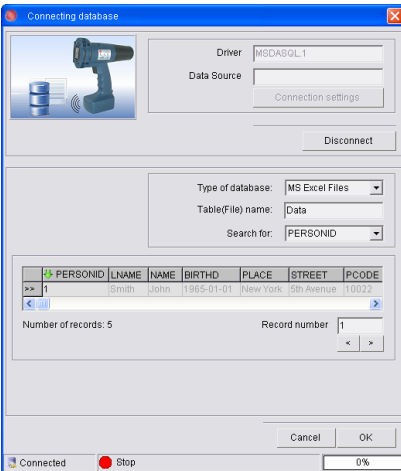

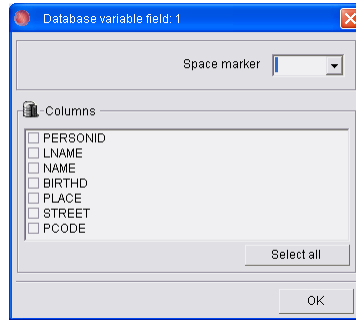

After connection with the database has been configured, the **Database variable field** window is displayed. Tick the names of the parameters (column headings) whose data is to be copied to the variable field and press the **OK** button. You can also

define the character to be used as a database data separator.



In order to choose other parameters (column headings), double-click on the database variable field in the list displayed in the Variable Field window.

In order to establish connection between the printer and the database, press the **Send** button or use the **Database** command in the **Tools MENU**.

The status bar of the window displayed shows the state of connection with the database and of communication with the printer, as well as the progress bar. The selected columns are displayed in green. In order to start transferring data to the printer, click the **Start sending** button. When the data has been transferred successfully, an audible signal **32**  is heard and the lamp **17** goes on. If the **Send automatically** option is enabled, text files are sent automatically after a given text has been printed. In the automatic transfer mode printing is blocked after every project has been printed until a successive text file is received (the same text cannot be printed several times). When printing is blocked, the PRINT lamp flickers. If this option is disabled, text files are sent only after printing has been switched off with the **18**  key. In the manual transfer mode printing is

not blocked and the same text file can be printed many times.

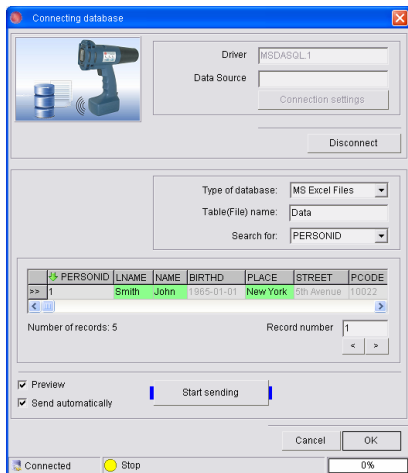

The printer can work with only one database at a time.

Every database table and Excel/TXT file shall have a column where successive records (lines) are numbered. In addition, every Excel spreadsheet shall have a heading.

The printer and PC shall be able to communicate with each other permanently.



The maximum number of columns in a table/file is 24 and the maximum number of lines in a table/file is 16 million.

Only Latin characters can be used in a database file (for example, no Cyrillic characters can be used).



No database variable field and no object counter register can be placed on a project at the same time.

For more information on the database refer to the document entitled *HANDJET EBS 250 Printer Database Operating Manual*.

## Print Preview

On creating a text to be printed with the use of the variable fields you can check for proper operation of the counters using the print preview option.

Use the  key to preview a print and initiate variable fields.

The  key is used to preview successive prints; it is available after the  key has been pressed once.

Define a text containing one or more variable fields (incremental or decremental counters, date and time, information from database).

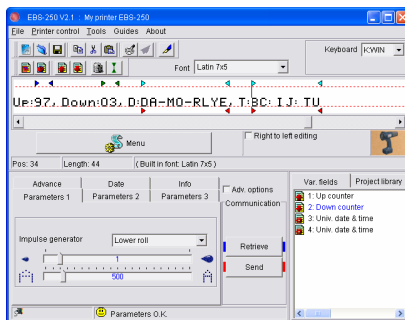

Check if the variable fields operate properly by using the print preview option. Press . In the Print Preview window you can see what the text looks like after the text, print and the printer's general parameters required have been applied.

If a text to be printed is defined as above, then the following contents can be printed on 30-09-2011 from 12:10 hours on, when printing is released with button 5 of the printer (simulated by the  key in the program):



## How to create and edit a graphics file for printing?

The graphics (bitmap) editor enables a user to create and edit drawings which can then be inserted into texts to be printed.

The graphics editor can be called up with the  key on the toolbar (see figure **F**).

The window where graphics can be created/edited consists of dots and enables a user to generate graphics with a maximum height of 16 dots and length of 60 dots.

Description of functions performed by the bitmap editor keys:

 - to insert bitmap into text file being edited,

 - to delete drawing being edited,

 - to select draw mode.

## How to Modify Print Parameters

### Character Resolution

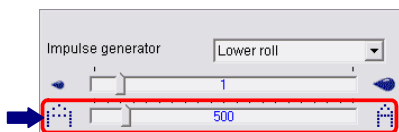

This parameter defines resolution (a number of **rows/metre**) of a text to be printed. The visual effect of any change in the **Text width** parameter is a change in the character width and in consequence, in the length of the entire text.

The settings of the parameter can vary between **5** and **4000** with the increment of **1**.

The settings of the **Text width** print parameter are restricted not only by the above mentioned range limits. The current setting is controlled by the printer control program and can be further reduced according to the settings of other print parameters. Any attempt to set too high a print rate is automatically rejected.



### Intensity of Ink Drops

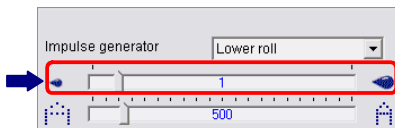

This parameter impacts on the volume of every ink drop jetted out of the print head. If you increase intensity, you make the diameter of drops and colour saturation in the print increase. The settings of the **Dot size** parameter range from **0** to **10** with the interval of **1**.



Any increase in intensity setting increases ink consumption.

### Mode of Timing

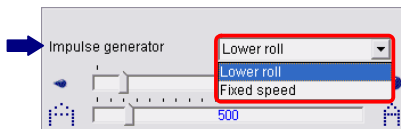

Timing determines the moments at which vertical rows of text are printed. Timing can be synchronised using:

- Lower guide roll **3** - set the **Impulse generator** parameter to **Lower roll**. The movement of the roll makes the axis of the built-in encoder rotate (rotational speed converter).
- Internal generator - set the **Impulse generator** parameter to **Fixed speed**.

The program makes it impossible to set the **Fixed speed** parameter unless the **EBS-250 Safe mode** option in the **Tools** menu, the **Preferences** submenu is unchecked. This limit has been set in order to reduce the risk of accidental print release – if the **Fixed speed** and **Text repetitions - Continuous** parameters are set, the printer starts printing as soon as printing is enabled with button 18 !!! When printing is timed by an internal generator, the print rate is not synchronised with the printer travel rate.



TEST 123456 or from right to left

The above reflections can also be used when you print on transparent surfaces, and printouts need to be legible from the other side (mirror images in the vertical or horizontal directions).

Select the **Reflect in vertical** and **Reflect in horizontal** parameters in order to make proper printouts when objects to be labelled are positioned upside down.



### Reflecting a text

The directions are defined as the printer "sees" them.

Advance	Date	Info
Parameters 1	Parameters 2	Parameters 3
<input type="checkbox"/> Reflect in vertical <input type="checkbox"/> Reflect in horizontal		
Text repetitions	1	
Print delay	0	
Rep. distance	0	
Character spacing	2	
Selective char. spacing	2	

Reflect in vertical  
 Reflect in horizontal

95421 1S31  
 TEST 123456  
 TEST 123456

the printer travels from left to right  
 Reversed view of the printout

Reflect in vertical  
 Reflect in horizontal TEST 123456

Select the **Reflect in vertical** parameter in order to make the print look like it is turned over.

Reflect in vertical  
 Reflect in horizontal 1E21 1S342Q

Select the **Reflect in horizontal** parameter if you need to label objects by moving the printer from the right-hand side to the left-hand side.

The following examples can be used in practice when the **Shaft direction** parameter is set to **Disabled** (this parameter is available in the **Advance** tab sheet after the **Adv. options** box has been ticked).



Reflect in vertical  
 Reflect in horizontal

### Rotating a Text

Advance	Date	Info
Parameters 1	Parameters 2	Parameters 3
<input type="checkbox"/> Reflect in vertical <input type="checkbox"/> Reflect in horizontal		
Text repetitions	1	
Print delay	0	
Rep. distance	0	
Character spacing	2	
Selective char. spacing	2	
	Rotation	0

As opposed to the **Reflect in vertical** and **Reflect in horizontal** parameters, which apply to entire texts, the **Rotation** parameter enables you to turn a single character.

A character can be turned clockwise (when the parameter is set to 90), counter clockwise (when the parameter is set to 270) or turned upside down (when the parameter is set to 180).

Text rotation can only be applied when Windows fonts are used.

Choose the angle of rotation for a character (text), and then type it in on the text edit line.

95421 1S31  
 TEST 123456

the printer travels from left to right

## Repeating a Text (Repetition)

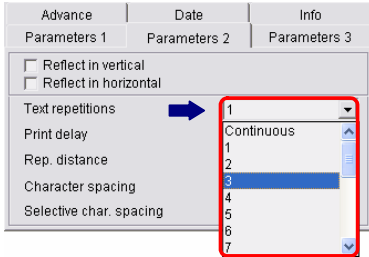

The **Text repetitions** parameter defines how many times printing needs to be repeated from the start point, after the printing has been initiated with release button **5**. You can print a text repeatedly on one object - this is a so called text repetition. For long objects (such as pipes, hoses, cables, strips) you can set the repeated printing parameter to **Continuous**. This is possible after the **Impulse generator** parameter is set to **Fixed speed**. The interval between texts is set with the **Rep. distance** parameter - see further below.

### Print Delay

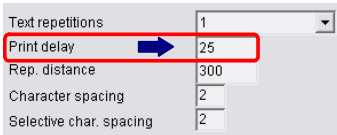

The **Print delay** parameter defines the distance between the point at which printing is released (with release button **5**) and the point at which printing should start. The distance is given as a number of empty rows to be timed after printing has been released until real printing starts. With it you can adjust the position of a print in relation to a reference point, for example the edge of an object. The settings of the **Print delay** parameter range from **0** to **9999** with the increment of **1**.

## Distance between Texts

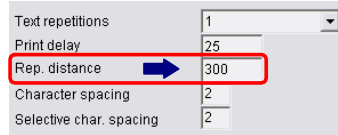

The **Rep. distance** parameter defines the distance between the beginnings of the texts that are printed repeatedly (**Text repetitions**>1). The distance is specified as a number of vertical rows (timed by a timing system). The settings of the **Rep. distance** parameter range from **0** to **9999** with the increment of **1**.

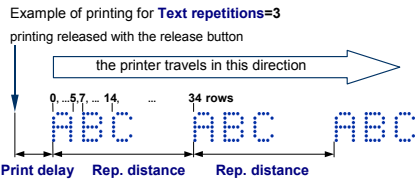

If the distance set with the **Rep. distance** parameter is smaller than the text length (given as a number of rows), then the texts will be printed one after another.

### Row Repetition

The parameter defines how many times printing of each vertical row should be repeated. It is used for intensifying the prints on porous surfaces, which soak up ink heavily, on which printed characters are poorly visible due to surface granulation, if the characters are built of ink dots of the same sizes.

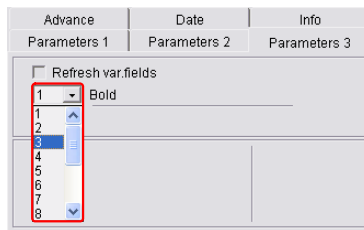



## Intelligent Control of Hand Movement

The printer system controls the printing process and makes it impossible to produce a misprint should the operator's hand or the printer be withdrawn by chance. The control is enabled if the **Shaft direction** parameter is set to **Compatible with printing direction** or **Contrary to printing direction** (depending on whether objects are labelled from left to right or from right to left). The system detects every withdrawal of the printer automatically and suspends printing. After the printer has returned to its proper position, printing is resumed from the place /text part in which the printer was drawn back.

The **Shaft direction** parameter is available in the **Advance** tab sheet after the **Adv. options** box has been ticked. If the parameter is set to **Disabled**, the printer will produce labels in either direction.



In order to ensure that printing is resumed exactly in the place where it was interrupted, the lower roll, **3**, of the printer needs to have contact with the surface to be labelled on a continuous basis.

## How to Transfer/Save Text Files to/in the Printer

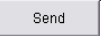
See figure **F**. In order to send a text and print parameters to the printer, you need to click the  key or use the command **Send text and parameters** from the **Printer control** menu. Wait until an **O.K.** message is displayed in the transmission status window.



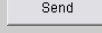
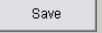

If you use the extended parameter panel (which is available after the **Adv. options** box has been ticked), the  key has a different function. When such a panel is used and text is sent to the printer, the text file is not saved in the printer's non-volatile memory at the same time. If the printer is switched off the text file is lost. In order to save the text file in the non-volatile memory press the  key or use the **Save text and parameters** command from the **Save text and parameters** menu. If you do that and switch the printer off and on, the text will be immediately ready for printing.



## How to Change a Text File Stored in the Printer

Every text file can be changed in two ways.

### Method One:

1. Retrieve a text file from the printer's memory by clicking the  key or the command **Retrieve text and parameters**.
2. Modify the text file and/or print parameters with the text editor.
3. Save the text file in the non-volatile memory of the printer by clicking the , bearing in mind that an **O.K.** message should be displayed in the transmission status window each time a file is saved.

See also the note in the section entitled **How to Transfer/Save Text Files to/in the Printer**.

### Method Two:

1. Open a project (text and parameters) with the command **Open project** or only a text file with the command **Open text (without parameters)** on your computer.
2. Save the text file in the non-volatile memory of the printer by

clicking the , bearing in mind that an **O.K.** message should be displayed in the transmission status window each time a file is saved.

See also the note in section **How to Transfer/Save Text Files to/in the Printer.**

## Printing

### Printing a Text File Saved in the Printer

See figure **A**.

1. Switch the printer on.
2. Press and then release button  - lamp **17** starts lighting. If ink pressure in the ink container is insufficient, a micro compressor starts to add some air. Wait until the micro compressor stops working.
3. Move the head of the printer to an object to be labelled to ensure that drive rolls **1** and **3** touch the surface of the object.
4. Press print release button **5** (the release button) and move the printer along the object ensuring that the drive rolls roll at a uniform speed.

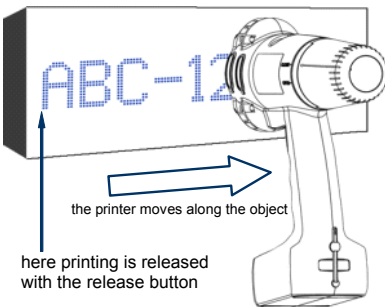

5. Make successive prints by pressing release button **5**.
6. After all prints have been made press and then release button **18**,

. Lamp **17** goes out. If the **Stop printing method** parameter is set to **Complete & stop** and you press button **18**, lamp **17** will flash. This means that you have pressed release button **5** but not finished printing. In such a case you can finish printing or abandon printing by pressing button **18** once again. If the **Stop printing method** parameter is set to **Immediate stop** the printer will not remind you about the unfinished printing.

The **Stop printing method** parameter is available in the **Advance** tab sheet after the **Adv. options** box has been ticked.

If the printer has been idle for longer than about 30 minutes, the nozzle outlets might become covered with dry ink. Before you start printing make a trial printing or use the rinse-the-nozzles function for a while in order to clear the nozzles - see **Rinse the nozzles.**



If you label objects whose height is smaller than 60 mm (the distance between the rolls is 60 mm), make sure that at least lower roll **3** (designed for synchronising printing) touches the object being labelled - see figure **H**. The rule does not apply if printing is synchronised by the internal generator.

### Line Printing

Line printing is used to print a few texts manually in a fast way:

- on consecutive lines as shown in the figure below:



- or in different places on an object as shown in the figure below:

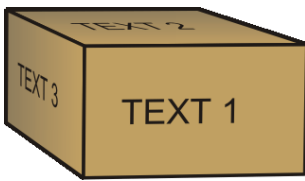

Create texts to be printed in the following way:

1. Create **TEXT 1** in the text edit line. Every line of the text can have all the text elements (such as variable fields, various fonts, etc.) described previously.

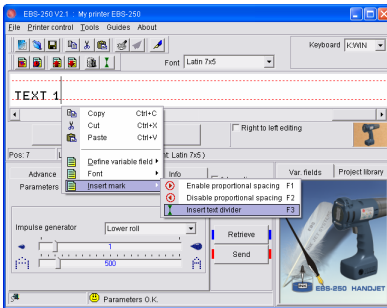

2. Place the cursor at the end of text **TEXT 1** and insert a text-change marker. You can do that in a few ways:

- while holding the cursor on the text edit line press the right mouse button (or the MENU button) and select the commands **Insert mark** and **Insert text divider** in the menu displayed,
- press the  key on the tool bar of the text edit window,
- use the F3 shortcuts.

3. Type in successive texts separating them with the text-change marker.

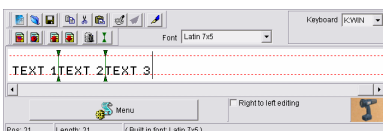

4. Transfer the text to the printer and you can start printing.

Each text is selected and printed with release button **5**.



The number of texts to be printed in separate lines is not limited. Instead, the total number of characters in all lines is subject to limitation: it must not exceed 1300 characters.

## Using a Number of Texts

You can store up to 10 projects (30 optionally) in the printer memory. Each project can contain any of the text elements described previously (such as variable fields, various fonts, etc.), and also the line printing function.

## Creating a Text Library in the Printer

1. In the **Project library** window, type in the name of a first text and confirm the name with the **(ENTER)** key.

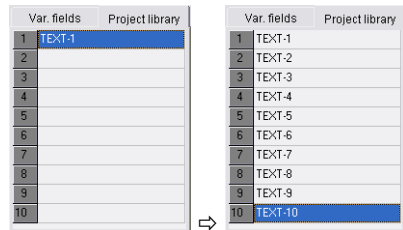

2. In the text edit line create a complete text and set print parameters for the text.



3. When the printer is on, click the

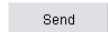

key of the printer control program in order to send the text file to the printer. See also the note in section **How to**

### Transfer/Save Text Files to/in the Printer.

- Repeat steps from 1 to 3 in order to programme other texts.

You can save the project list to a text file using the **Copy list to editor** command which is available after the right mouse button has been pressed above the text library window.

### Quick Saving/Retrieving Text Files to/from Text Library

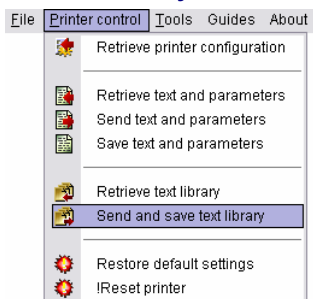

In order to save the entire text library to the printer use the command **Send and save text library**.





Similarly you can retrieve the text library from the printer using the command **Retrieve text library**.

 The command **Send and save text library** erases all text files contained in the non-volatile memory of the printer.

### Printing Text Files from Library

Select texts stored in the text library of your printer one by one by pressing button **19** -  for a while until buzzing is heard from buzzer **32** . Such a switching operation can be performed regardless whether the printer is in the *print* state (lamp **17** lights) or not. The buzzing from buzzer **32**  is different for a first text. On display **33** you can see which of the library texts is selected. The

number displayed corresponds to the number in the text library.

- Start printing by pressing button **18** - .
- Print a text.
- Switch the printer to print another text by pressing button **19** - .
- Print the successive text.

In order to ensure that the printer skips over text files during the text switching operation (to be performed with function key **19**) delete the text name in the library and save such an empty text name in the printer.

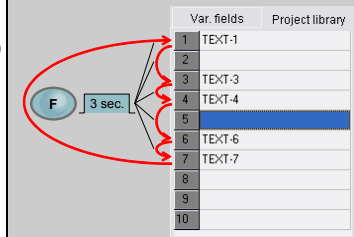

### Saving the Project Library on Computer Disc

The project (text and print parameter) library can be saved on a computer disc with the command **Save project library** from the **File** menu.

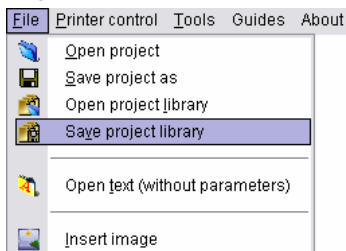

Similarly you can open the project library on your computer with the command **Open project library**.

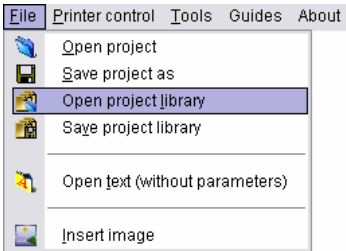

You can quick-load the project library from the computer disc to your printer with two successive commands **Open project library** and **Send and save text library**.

## Maintenance, Storage and Transport

- ◆ It is recommended that the outer face of the print head, especially the nozzle plate **2**, and possibly the guide rolls **1** and **3** should be washed in order to remove the remnants of ink and dirt after the work has been finished and the printer has been switched off. The washing should be done in the following way:
  - Place the HANDJET printer on its side and tilt its face downwards carefully (see the drawing below); in such a position dirty wash-up can flow freely out of the printer,
  - Place a piece of absorptive cloth or a metal vessel, e.g. a tray, under the printer face,
  - Wash the printer face with the use of a wash-up atomiser.

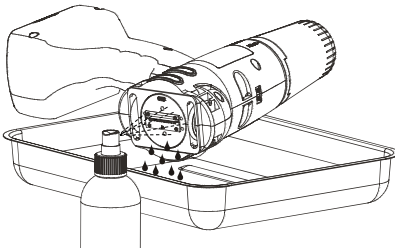

If the printer face is washed in a different way than that shown above, then wash-up may get in to the printer's movable, bearing-based parts or inner electronic subassemblies unintentionally. In effect, the roll guides may seize or ever lockup permanently and the (shaft-encoder) position sensor and other electronic subassemblies may get damaged.



- ◆ If the printer remains idle for a longer period (over 3 weeks), ink may partially dry in printer components. Therefore follow the storage instructions given below not to be disappointed when you try to use your printer afterwards:
  - if the printer has already been used before, store it with ink container **10** fastened to it,
  - protect the printer against dust, dirt, any influence of aggressive vapours and gases and excessive temperature and moisture. Ideally, place the printer in a polyethylene tight bag, remove air from the bag and close it tightly. Then place it in the packing case.
- ◆ The printer should be stored and transported in the packing case delivered with the printer. During normal operation avoid exposing the printer to strong mechanical shocks (protect the printer, especially nozzles **2**, rolls **1** and **3** and panel **9** against impact, falling onto hard surfaces or scratching with sharp objects).

## Problems with Functioning and Operation of the Printer

### *Some of the nozzles do not jet ink*

#### *Rinse the nozzles*

Some drops are missing on a print.

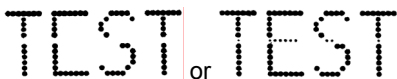

- ◆ Aim the nozzle outlet at a vessel, for example the one you use to wash the printer.
- ◆ Wash the nozzles with wash-up, if they are covered with dried ink.
- ◆ Start the rinse-the-nozzle function. Press release button **5** three times and hold it down for a few seconds. This causes all electromagnets in the head to open and ink to pour out at pressure after a warning buzzing signal has been generated by buzzer **32**  !
- ◆ When ink starts jetting regularly out of each nozzle, release button **18**.



Frequent and long-lasting use of the rinse function increases ink consumption.

#### *The printer does not print*

On starting printing and making an attempt to print you can hear the electromagnets of the nozzle valves operating but ink drops are not always jetted out of the nozzles properly. The quality of printing deteriorates or no print is produced.

After about 100 ink containers (or over 10 litres of ink) have been consumed, however not less frequently than every four years, the built-in ink filter should be checked and replaced, if need be. It is recommended that the

replacement operation be performed by qualified or EBS service staff.

#### ***Boldfaced or Blurred Prints***

The print is heavily saturated with ink, ink drops blur and the entire print seems to spread over the object being labelled.



Decrease the setting of the **Dot size** parameter by moving the parameter slider to the left.

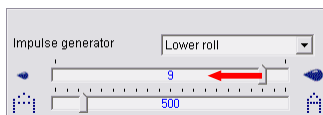

## Questions and Problems

If these Instructions and other support in the form of electronic files contained on the installation CD, which has been delivered together with the printer, do not provide answers to all your questions, then:

- ◆ look through the web site of the printer's manufacturer, EBS Ink-Jet Systeme and try to find the answers to your queries,
- ◆ try asking the question to the manufacturer's representative,
- ◆ present the problem in the contact form available on the manufacturer's web site and forward the form following the instructions given therein.

## Electronic Guides

Some operating instructions and programming operations are presented via interactive creators/guides available from the **Guides** menu of the control program. The creators are installed together with the control program.



## Technical Parameters

Parameter	Description
Number of nozzles	16
Nozzle diameter	150µm as standard optionally: 120µm, 170µm, 200µm.
Print height	27 mm
Height of objects to be labelled	<b>from 70 mm</b> (contact with both rolls), <b>from 35 mm</b> (contact with the lower roll to print with for example 7 nozzles only - see figure  ). A guide and rolls can be used optionally to support rectilinear printing; they are most useful for line printing, for labelling pipes, barrels and other cylindrical objects.
Working position in 3D space	any
Number of text lines per run	1
Line printing	Supports printing of up to 10 texts in successive lines.
Maximum number of characters per text	1300 (including control characters for the printer's built-in fonts).
Number of texts and accompanying print-parameter (stored in the printer's memory at the same time)	<b>from 1 to 10</b> . Texts are loaded to the printer via a PC. <b>from 1 to 30</b> Optionally.
Printing of graphics (logo, special graphics characters)	Ability to edit and print text and graphic symbols with the application of Windows® fonts (True Type fonts) as well as with a bitmap editor, as standard.
Special characters	National (diacritical) characters, graphic characters for information, warning, transport and other purposes (a character set defined by the manufacturer), etc.
Variable fields (texts whose contents vary dynamically according to occurrence of a specific event)	Date and time in any format, expiry date, incremental or decremental counters.

Parameter	Description
Timing	Either synchronised with rotational speed of the lower guide roll or at time intervals by an internal generator regardless of the printer's travel rate during printing.
Programming	<ul style="list-style-type: none"> <li>Text and parameter processing software compatible with Windows® 98SE / ME / 2000 / XP / Vista®,</li> <li>Programming with the use of <b>T200</b> Terminal (optionally),</li> <li>The option of networking of up to 60 printers; such a network is radio-controlled via a PC.</li> </ul>
Printer-computer communication: Operating frequency range: Range:	Wireless link, radio transmission with Bluetooth 2.0, Class 1 <b>2.400 - 2.485 GHz</b> <b>up to 100 m</b> , according to land-surface configuration
Power supply	<b>Battery</b> powered with a pack of 3 Li-Ion cells.
Approximate operating time with the battery fully charged	<b>50 hours</b> of non-stop printing at the temperature of 20°C, automatic low-battery indication.
Re-charging	Automatically via an external <b>24V<sup>===</sup> / 1 A DC</b> power pack. Charging time - <b>less than 150 minutes (&lt;2.5 hours)</b> . Number of charging cycles: <b>500</b> (up to 70% of initial capacity).
Ink	It is available in easy detachable containers. It is made on the basis of alcohol, acetone or water, in various colours (among others in white, yellow, blue, green, red or black) to be ordered from a catalogue.
Container capacity	<b>110 ml</b> enough to print about 100 000 characters with 7x5 dot matrix or about 17 000 characters with 16x10 dot matrix,



Parameter	Description
<b>Working pressure</b>	from <b>0.03 MPa to 0.04 MPa</b> (from <b>0.3 bar to 0.4 bar</b> )
<b>Operating temperature range</b>	from <b>+5°C to +40°C</b>
<b>Storage temperature range</b> (over a longer period)	from <b>+1°C to +45°C</b> , if water-based ink is used for printing. from <b>-10°C to +45 °C</b> if acetone or ethanol-based ink is used for printing.
<b>Humidity</b>	Up to <b>95% without steam condensation</b> - at temperatures higher than the dew point (the printer can be operated when it rains provided that the surface to be labelled is dry).
<b>Weight</b>	<b>980±10 g</b> printer with a battery and full ink container, without power pack and cable.
<b>Dimensions in vertical position</b> (length / width / height)	<b>240 / 130 / 265 mm</b>
<b>Dimensions in working position</b>	See figure <b>H</b> below (provided that the surface to be labelled is vertical).



## Printer Accessories

**NOTE:** some elements may not be part of a typical delivery or other elements which are not specified below may be included, depending on your order.

- ❑ The following elements are delivered most frequently as part of a typical system:
  - Packing case to hold all accessories ..... 1 unit
  - HANDJET® EBS 250 Printer ..... 1 unit
  - Power pack (24V==/1A) with cable ..... 1 unit
  - Ink container ..... 2 units
  - USB-Bluetooth Radio Communications Module ..... 1 unit
  - CD with utility software, operating instructions and user-support files (instructions, advice, help in electronic form) ..... 1 disc
- ❑ Other elements to be delivered with the order as part of the system or separately:
  - Double guide rolls to support rectilinear printing,
  - Quadruple guide rolls to support rectilinear printing,
  - Guide rolls on cylinder-shaped elements to support rectilinear printing (at the radius length – along the perimeter),
  - Guide rolls on cylinder-shaped elements to support rectilinear printing (along the axle - longitudinally).

### H

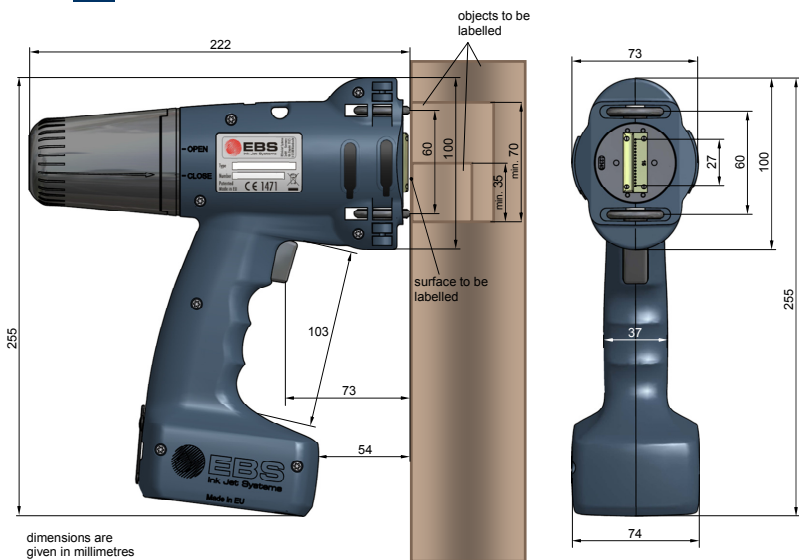

The printer in its working position - dimensions (side and front views)



---

**EBS Ink-Jet Systeme GmbH**

Alte Ziegelei 19-25,  
D-51588 Nümbrecht, Germany

☎ +49 (0)2293 - 939-0

📠 +49 (0)2293 - 939-3

<http://www.ebs-inkjet.de>

**EBS Ink-Jet Systems Poland Sp. z o.o.**

ul. Tarnogajska 13,  
50-512 Wrocław, Poland

☎ +48 71 367-04-11

📠 +48 71 373-32-69

<http://www.ebs-inkjet.pl>